



**UNIVERSIDAD AUTÓNOMA DEL
ESTADO DE MÉXICO**

FACULTAD DE CIENCIAS

**“ACTINOMETRÍA DE MEZCLAS DE PLASMAS
DE BAJA ENERGÍA”**

T E S I S
POR ARTICULOS ESPECIALIZADOS

PARA OBTENER EL GRADO DE
MAESTRO EN CIENCIAS

PRESENTA

FÍS. MARCOS CRESCENCIO GONZÁLEZ DOMÍNGUEZ

ASESORES

DR. PEDRO GUILLERMO REYES ROMERO

DR. HORACIO MARTÍNEZ VALENCIA



TOLUCA, ESTADO DE MÉXICO, 15 DE MARZO DE 2017.

Determination by actinometry of the dissociation fraction, electron temperature and electron density of the glow discharge of the mixture N₂/Ar

M C González¹, P G Reyes¹, A Gómez¹, and H Martínez²

kenny.sxe4@gmail.com¹, pgrr@uaemex.mx¹, agomezd@uaemex.mx¹, hm@fis.unam.mx

¹Facultad de Ciencias, Universidad Autónoma del Estado de México, Instituto Literario 100, Col. Centro, C.P. 50000, Toluca, Estado de México, México.

²Instituto de Ciencias Físicas, Universidad Nacional Autónoma de México, P. O. Box 48-3, 62210, Cuernavaca, Morelos, México.

Correspondence should be addressed to P.G. Reyes: pgrr@uaemex.mx

The properties of low-pressure glow discharge N₂/Ar plasmas were investigated using optical emission spectroscopy (OES) under pressure in the range of 2.0 Torr. The percentage of Ar in the system was varied between 10% and 100%, and 250–260 V power was applied. Actinometry is developed for quantitative determination of nitrogen dissociation fraction in glow discharge; In this study, Ar was used as an actinometer and adding gas. The effect of Ar content in the gas mixture was examined and the effects of pressure on the dissociation fraction of N molecule were investigated. It was found that the dissociation fraction increased with increasing Ar content. In addition, the electron temperature and electron density were obtained using OES.

1. Introduction

Among the various gas mixtures that generate plasma, the N₂/Ar mixture is of much interest because N₂/Ar plasmas can generate nitrogen species such as N₂ atoms, N₂ molecules in the excited state and molecular ions. These species play an important role in the field of

material science and have important technological applications such as metal nitriding, sterilization of medical instruments, and activating and modification of the polymer surface.

An important parameter for synthesizing N_2 plasmas is the calculation of its degree of dissociation. Several studies have been theoretically and experimentally performed in relation to the dissociation of N_2 within plasmas of this species. Experimentally, one of the promising methods for measuring the degree of dissociation is actinometry, which is based on optical emission spectroscopy (OES).

The dissociation fraction of N_2 molecules is enhanced in an N_2/Ar discharge under the influence of Ar in the discharge, where an increase is observed in the dissociation fraction of N_2 molecules at high concentration, which is attributed to the contribution of charge exchanges between Ar^+ and N_2 followed by the dissociation recombination process [1].

2. Experimental details

The schematic of the experimental setup is illustrated in figure 1 [2]. The DC glow discharge plasma mixture of N_2 and Ar gases was generated in a reactor at the Advanced Physics Laboratory of Science Faculty, Universidad Autonoma del Estado de Mexico. The discharge cell comprised two movable parallel electrodes enclosed in a stainless steel vacuum chamber. The electrodes were positioned at the center of the reaction chamber with a 20 mm gap spacing.

A DC glow discharge was produced between the two electrodes. While maintaining the total pressure at 2.0 Torr, the concentration of Ar gas in the mixture was varied by changing the Ar partial pressure. To maintain a constant current of 10 mA that was independent of the gas mixture, a ballast resistance was used; this was achieved by changing the power supply voltage (Spellman SA4) between 260 V (for 100 % of Ar) and 250 V (for 100 % of N_2). A quartz window was used to monitor the active species generated in the glow discharge by plasma emission spectroscopy; the spectrum (200–1100 nm) of the emission cell was measured using a spectrometer (Ocean Optics HR4000CG-UV-NIR) [2].

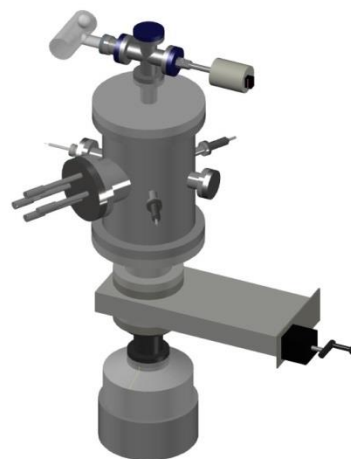
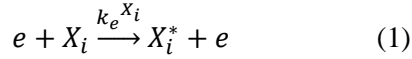

Figure 1. Schematic of the experimental apparatus

3. Actinometry

Actinometry is a tool of OES, which determines the absolute density of excited species in plasma, relating the intensity of the emission lines and the percentage of each gas supplied to generate plasma.

The method is based on the following procedure. A small amount of the actinometer (Ar in this case), is introduced into the discharge. If the emitting state of the actinometer and examined gas are excited by a direct electron impact from the ground state and have similar excitation potential, the same group of electrons will take part in populating these states [1].



The de-excitation of the excited states X_i^* must be radiative,

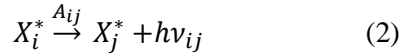

In this case, equations for the intensities of the emission lines of the actinometer and the emitting gas have the same form,

$$I_X = K_X h\nu_X A_X \tau_X n_e [X] k_X^{dir} \quad (3)$$

where K_X a factor depending on plasma volume, h is Planck's constant, ν_X is the frequency of transition, A_X is the probability of spontaneous emissions for the transition, τ_X is the lifetime of the excited state, n_e is the electron density, $[X]$ is the concentration of

the corresponding gas and k_X^{dir} is the rate coefficient of the analyzed species [3,1].

4. Electron Temperature

A common technique to measure electron temperature and electron density is to implement a Langmuir because of its simple manipulation. However, this probe technique has numerous potential problems. Being intrusive, it is difficult to interpret the measurement and can often lead to errors. Thus, non-intrusive optical measurements of the plasma parameters are often desired.

Electron temperature can be determined by a commonly used spectroscopic technique called the spectroscopy diagnostic method. In this method, the intensities of several spectral lines having different threshold excitation energies are employed to determine electron temperature by assuming that the population of the emitting levels follows the Boltzmann distribution [4].

For calculating electron temperature, the following expression was used.

$$T_e = \frac{E_m(2) - E_m(1)}{k} \left[\ln \left(\frac{I_1 \lambda_1 g_m(2) A_m(2)}{I_2 \lambda_2 g_m(1) A_m(1)} \right) \right]^{-1} \quad (4)$$

where $E_m(i)$ are the energies of the upper levels of the lines, k is the Boltzmann constant, $g_m(i)$ is the statistical weight of the upper levels and $A_m(i)$ are their corresponding transition probabilities. These values are from the NIST Atomic Spectra

Database Lines [5]. I_1 and I_2 are the relative line intensities of lines in questions, λ_1 and λ_2 are wavelength of the lines, which were experimentally measured.

5. Electron density

In this study, also determine the value of electron density in the plasma, which is a fundamental parameter for investigating the status of the existing balance in the plasma. Electron density refers to the average value per unit volume of electrons presents in the plasma. Electrons are responsible for most of the processes taking place in the discharge. To determining electron density n_e , the method of the relationship between intensities of two lines of different degree of ionized is applied. To apply this method, it is necessary to consider the Boltzmann distribution. In this case, for calculating the electron density, the Saha–Boltzmann equation was used.

$$n_e = 6 \times 10^{21} (T_e)^{\frac{3}{2}} (\exp[-E_i/kT_e]) \quad (5)$$

where T_e is the electron temperature, E_i is the ionization energy of the species, and k is the Boltzmann constant [6, 7, 8].

6. Dissociation Fraction obtained using Actinometry

An important parameter in N_2 plasma is the dissociation fraction (D_{OES}) within the discharge. Actinometry is a convenient and practical method that allows us to relate the

emission lines of atoms and molecules that are present in the generated plasma. We can express the emission lines for N_2 atoms, Ar and molecular N_2 in the following manner by considering equation 3:

$$I_N = K_N h \nu_N A_N \tau_N n_e [N] k_N^{dir} \quad (6)$$

$$I_{Ar} = K_{Ar} h \nu_{Ar} A_{Ar} \tau_{Ar} n_e [Ar] k_{Ar}^{dir} \quad (7)$$

$$I_{N_2} = K_{N_2} h \nu_{N_2} A_{N_2} \tau_{N_2} n_e [N_2] k_{N_2}^{dir} \quad (8)$$

Where the ratio of intensities can be expressed as follows [9]:

$$\frac{I_N}{I_{Ar}} = \frac{K_N h \nu_N A_N \tau_N}{K_{Ar} h \nu_{Ar} A_{Ar} \tau_{Ar}} \left(\frac{[N] k_N^{dir}}{[Ar] k_{Ar}^{dir}} \right) \quad (9)$$

The density ratio $[N]/[Ar]$ is given by [3, 9]:

$$\frac{[N]}{[Ar]} = 1.91 \frac{I_N}{I_{Ar}} \frac{k_{Ar}^{dir}}{k_N^{dir}} \quad (10)$$

D_{OES} of N_2 is defined as the ratio of the N_2 atoms $[N]$ to the initial number of N_2 molecules $[N_2]_i$ at plasma temperature [10]:

$$D_{OES} = \frac{[N]}{2[N_2]} = 0.75 \frac{I_N}{I_{Ar}} \frac{X_{Ar}}{X_{N_2}} \quad (11)$$

In this equation, I_N and I_{Ar} are the emission intensities of N ($\lambda = 746.83$ nm) and Ar ($\lambda = 750.38$ nm), respectively, whereas X_{Ar} and X_{N_2} are the percentage Ar and N_2 in the plasma gas, respectively.

In this study, using OES, we obtain the dissociation fraction for a glow discharge N_2/Ar mixture as a function of Ar content. For optical emission actinometry, the

emissions of the N_2 line at 746.83 nm ($3p^4S_{3/2}^0 - 3s_4P_{5/2}$) and Ar line at 750.4 nm ($2p_1 - 1s_2$) are selected because they are not sensitive to two-step excitation [11].

7. Result and Discussion

An OES measurement for a mixture of 80% N_2 and 20% Ar at a total pressure of 2.0 Torr is displayed in figure 2. This figure shows the intensities of all observed emission bands and lines. Only the most intense spectral lines of N, N_2 , N_2^+ , and Ar and bands of N_2 and N_2^+ within the 200–1100 nm range are quoted. The observed transition lines are listed in table 1.

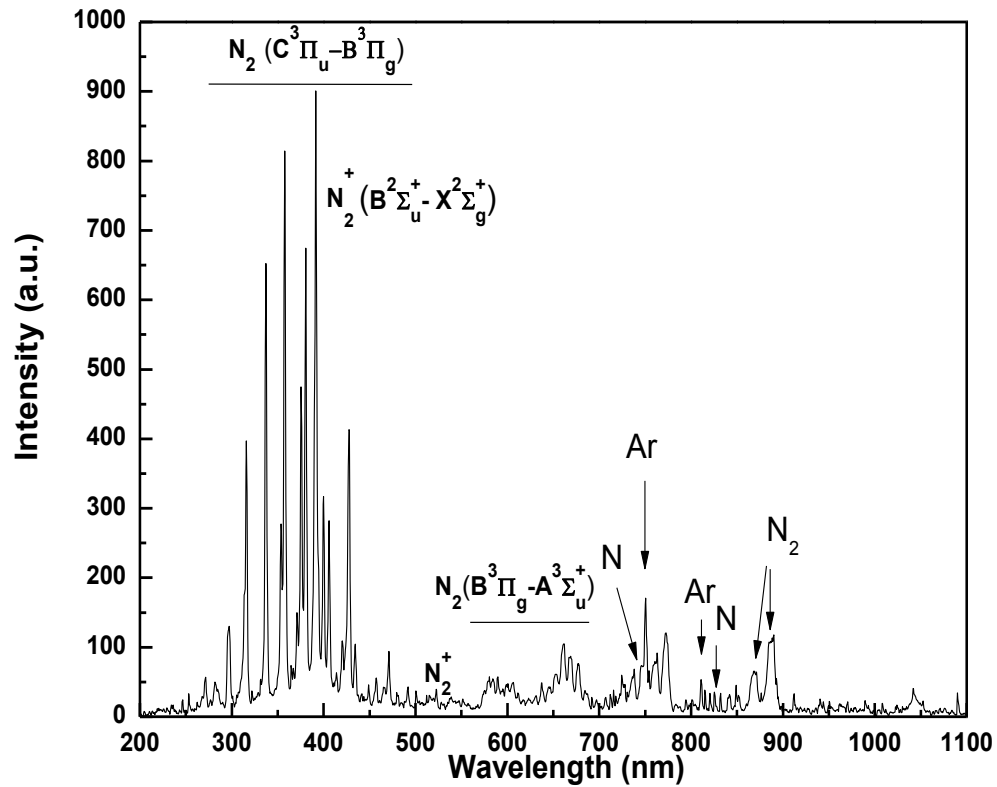

Figure 2. Spectra of emission measurements of 80% N_2 /20% Ar under 2.0 Torr pressure.

Table 1. Spectroscopic data related to atomic lines and molecular species of N₂/Ar plasma.

<i>species</i>	<i>λ (nm)</i>	<i>Upper configuration</i>	<i>Lower configuration</i>	<i>E_{Up} (eV)</i>	<i>g_{up}</i>	<i>g_{lo}</i>	<i>τ (ns)</i>	<i>A_{ij} (10⁷s⁻¹)</i>
N	746.83	3p ⁴ S _{3/2} ⁰	3s ⁴ P _{5/2}	11.99	4	6	26.3	1.9
N	824.24	3p ⁴ P _{3/2} ⁰	3s ⁴ P _{5/2}	11.84	4	6	0.763	1.31
Ar	750.4	2p ₁	1s ₂	13.48	3	1	0.22	4.45
Ar	811.53	2p ₉	1s ₅	13.08			0.302	3.31
N ₂	337.1	C ³ Π _u , v' = 0	B ³ Π _g , v' = 0	11.1				
N ₂ ⁺	391.4	B ² Σ _u ⁺ , v' = 0	X ² Σ _g ⁺					

Spectral lines and bands from the radiative state of N, N₂, N₂⁺, and Ar are identified in the emission spectrum, where the following transitions are observed: N(3p⁴S_{3/2}⁰ - 3s⁴P_{5/2}), N(3p⁴P_{3/2}⁰ - 3s⁴P_{5/2}), N₂(C³Π_u - B³Π_g), and N₂⁺(B²Σ_u⁺ - X²Σ_g⁺).

The reactions considered to be present within our systems among various species of N₂ and Ar are shown as equations 12, 13, 14, and 15.

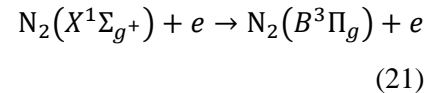
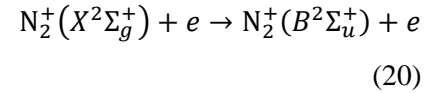
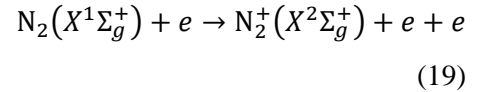
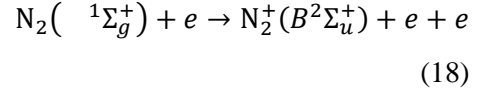
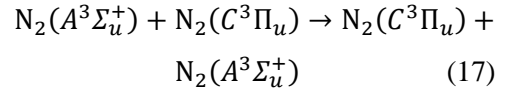
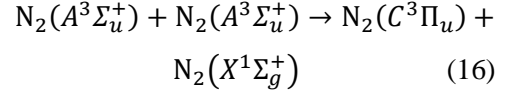
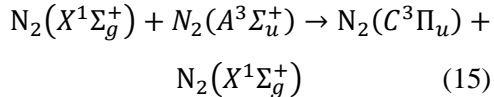
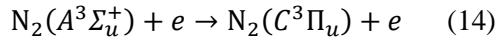
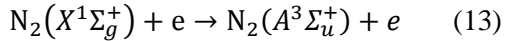
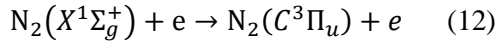

$N_2^+(B^2\Sigma_u^+)$ can be populating by electrons from the ground state of the neutral N_2 molecule $N_2(X^1\Sigma_g^+)$ via electron impact excitation (18) or stepwise via ionization and subsequent excitation of the molecule ion (19, 20). One ionization mechanics is electron impact on the neutral N_2 molecule and another mechanics present a low pressure is Penning ionization during the collision of metastable N_2 molecules. The excitation can take place by electron impact or by collision with the $N_2(X^1\Sigma_g^+)$ molecule, where the radiative state $N_2(C^3\Pi_u)$ is populated by many excitation and quenching processes such as electron impact excitation from the molecular ground state $N_2(X^1\Sigma_g^+)$ and first metastable state $N_2(A^3\Sigma_u^+)$, and transfer of energy between collisional partners and Penning excitation (12-17).

When adding Ar in N_2 plasma, there is an increase in the emission intensities, and consequently, the concentration of the active species can be determined by the Penning effect [16].

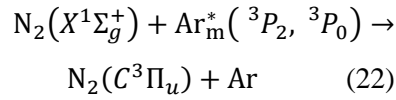

The ground state molecular ions can also be produced by the metastable Ar atoms ($^3P_2, ^3P_0$) by Penning ionization [17].

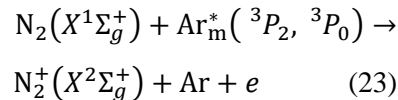

$N_2^+(X^2\Sigma_g^+)$ can be further excited by impact of the metastable Ar atoms. In conclusion, the population of the excited state of the molecule N_2 is caused by the transfer of internal energy from a metastable state of Ar atoms to the ground state of the N_2 molecule [15].

7.1. Variations in Electron Temperature and Electron Density

The introduction of Ar in the plasma synthesis process results in an increase in electron temperature and electron density as shown in figure 3. This is the result of the competition of electrons between Ar and N_2 during the kinetics excitation/ionization process. These modifications are reflected in the spectra emitted by the discharge, where a strong reduction of bands belonging to molecular N_2 is accompanied by the appearance of emissions from the excited species of Ar [4]. This increase in electron temperature may be explained as follows: Ar has a smaller electron collision cross section ($10^{-21}m^2$) as compared to molecular N_2 ; thus, an increase in the number of Ar atoms in the mixture decreases electron collision frequency and provides enough time for electrons to be accelerated owing to the electric field. In other words, increasing the number of Ar atoms increases the kinetic energy of the electrons. These high-energy electrons may directly excited and ionize N_2

or bring Ar to its metastable state, which in turn may collide with N_2 molecules and excite or ionize them by utilizing their internal energy. The lines used to evaluate

electron temperature by the Boltzmann method using equation 4 were Ar 750.4 nm and Ar 811.5 nm. T_e was found to be between 2.474 and 2.794 eV [18].

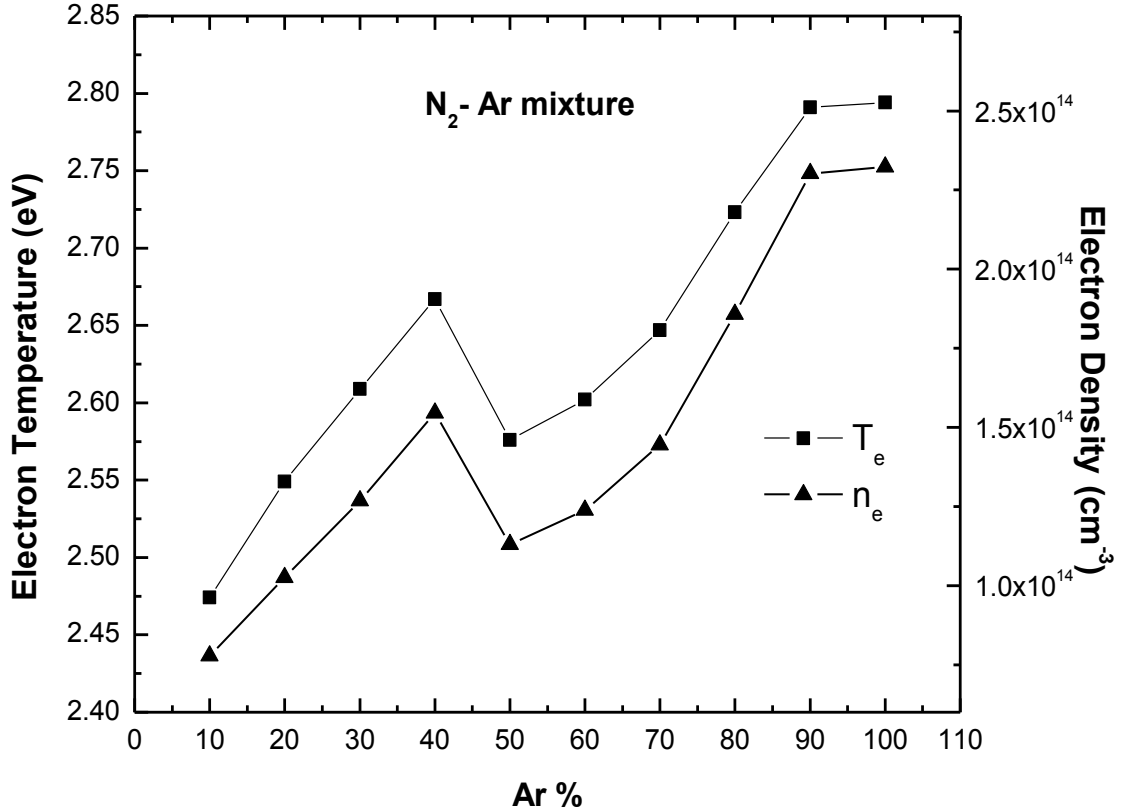

Figure 3. T_e and n_e as a function of the Ar percentage.

In the case of electron density, the density increases with Ar content in the mixture. If we take into account the increase in population of $N_2^+(B^2\Sigma_u^+)$ state with the addition of Ar, the increase in electron number density may be attributed to this ionization process of molecular N_2 . The concentration of $N_2^+(B^2\Sigma_u^+)$ states in this plasma will also increase by the Penning

effect of Ar metastable atoms. For a fixed power, with increase in the Ar content, the total energy loss per electron-ion pair decreases. Hence, electron density increases owing to the power balance.

8. Nitrogen Dissociation in N_2/Ar

Figure 4 shows the variations of intensity according to equations 6, 7, and 8 as

functions of Ar percentage. Ar percentage dependence of N (746.83), Ar (750.4), N₂ (337.1), and N₂⁺(391.4) intensity is displayed in figure 4, where the following can be observed: N₂ and N₂⁺ exhibit a decreasing

behavior as a function of Ar percentage and the Ar intensity exhibits an increasing behavior as a function of Ar percentage. For the case of N, the variations are very small which can say that is constant [1]

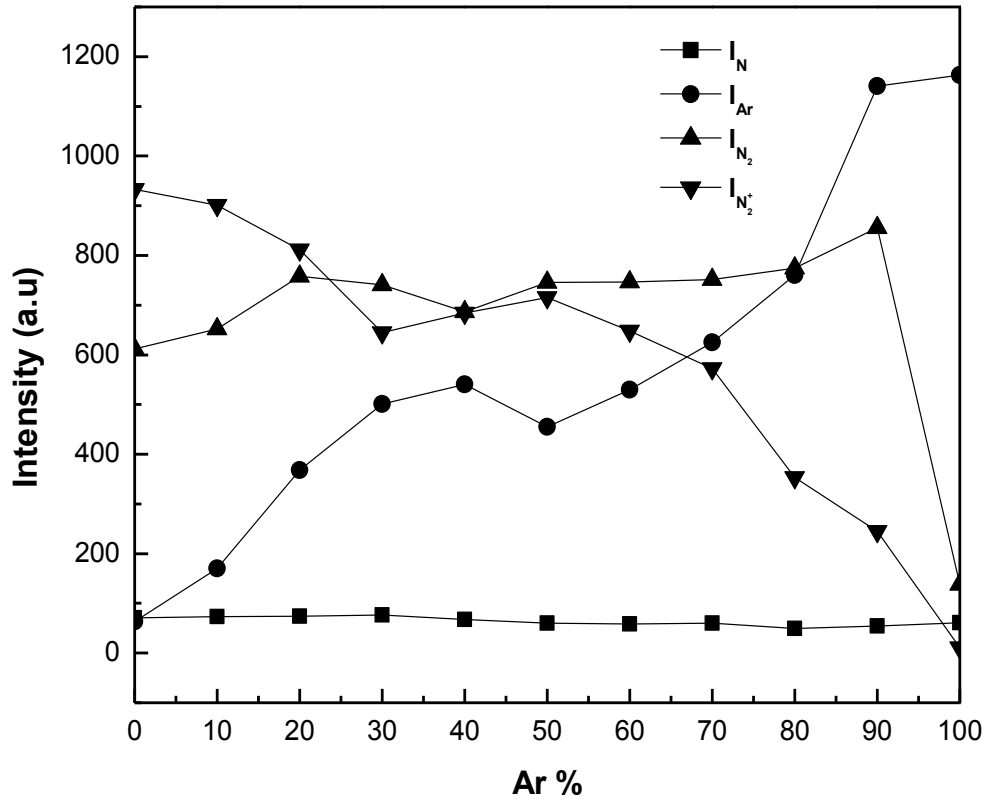

Figure 4. Intensity of principal peaks of the mixture as a function of Ar percentage.

Figure 5 shows the changes in the intensity ratios of the chosen spectral lines to the Ar content for N₂/Ar according to equation 9. The population of Ar (2p₁) and Ar (2p₉) increases more than that of N (3p⁴S⁰) with increasing Ar content. Thus, the ratio

I_N/I_{Ar750} decreases with increasing Ar content. Moreover, the generation of N₂⁺(X) and its excitation to N₂⁺(B) and the production of Ar^m increase with the Ar content. This promotes the Penning excitation $Ar^m + N_2^+(X) \rightarrow N_2^+(B) + Ar$.

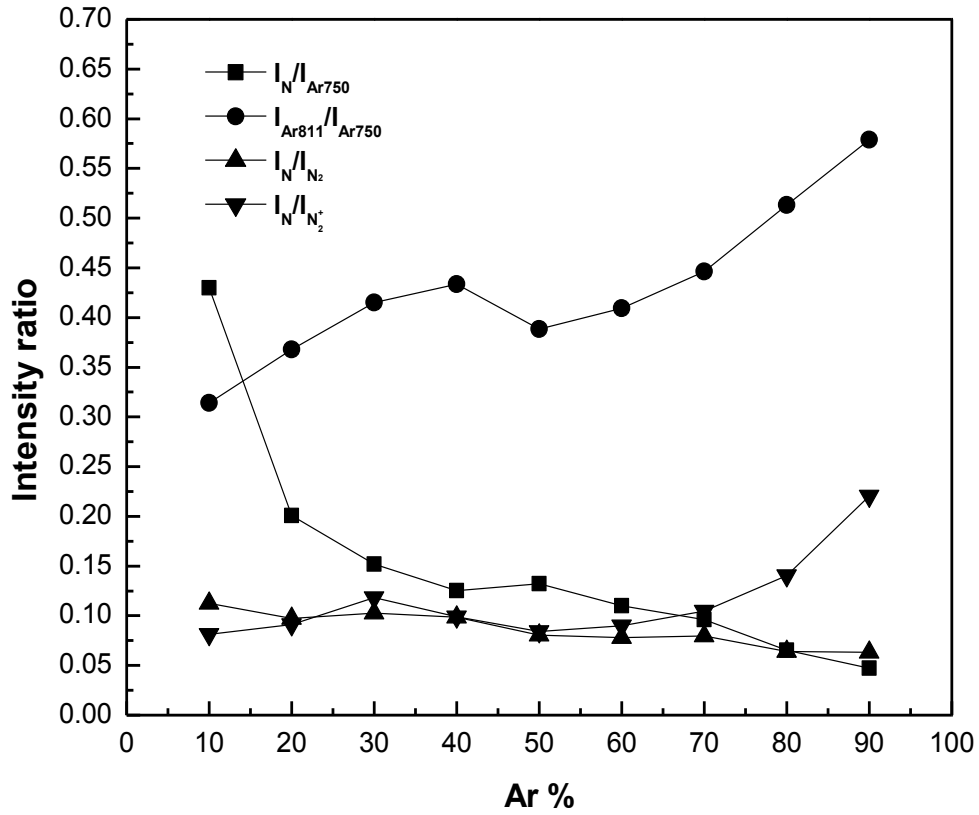

Figure 5. Intensity ratio of the chosen spectral lines versus Ar content in the mixture.

The population of Ar^m increases with the Ar content; this statement is reflected in I_{Ar811}/I_{Ar750} , given that the metastable states of Ar (3P_2 , 3P_0) have higher energies of 11.55 and 11.72 eV, respectively, than the threshold excitation energy (11.1 eV) of the N_2 molecule. In the case of I_N/I_{N_2} , as the Ar

content increases, this ratio remains almost unchanged. As pressure increases, the Penning ionization of N_2 and the charge transfer to N_2^+ are enhanced; therefore, the ratio $I_N/I_{N_2^+}$ decreases in 40% Ar/60% N_2 and 50% Ar/50% N_2 [19].

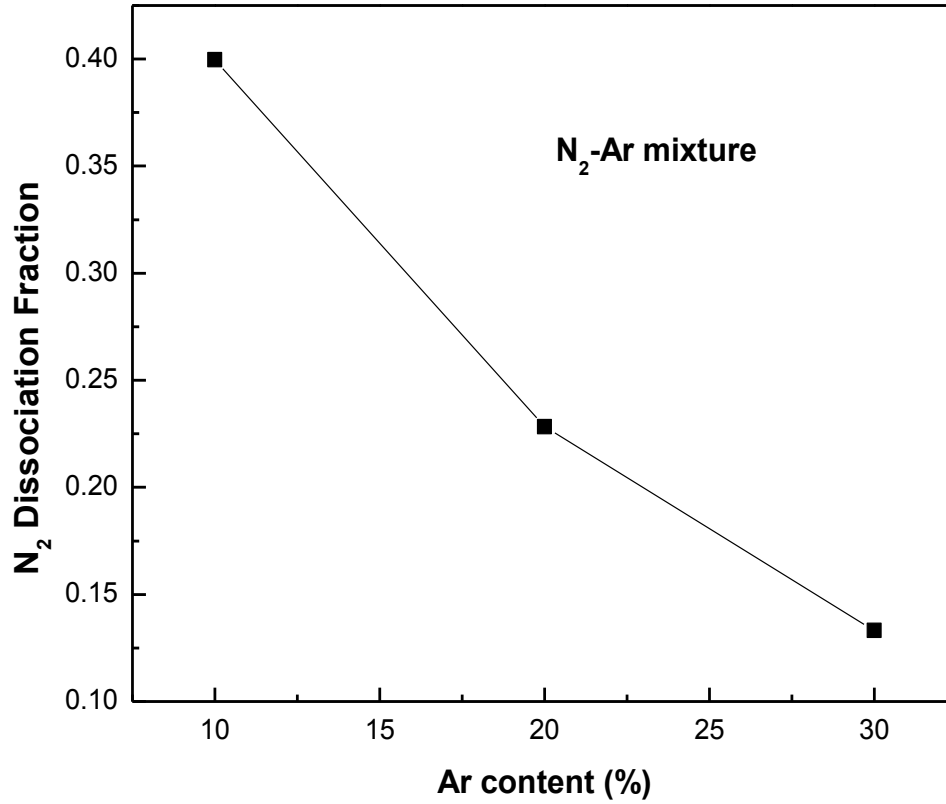
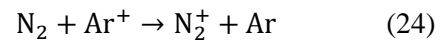

Figure 6. N₂ dissociation fraction degree as a function of Ar

Figure 6 show the dissociation fraction of the N₂ molecule present in the N₂/Ar mixture; this result was calculated using equation 11. The dissociation fraction decreased with increasing pressure and at low pressures in the N₂/Ar mixture, the dissociation of the N₂ molecules is favored in presence of 90% N₂ and 10% Ar [9], giving rise to N₂ atoms that are the basis of nitriding processes. In our case, at a pressure of 2.0 Torr, the maximum density of nitrogen atoms in the discharge was achieved at 10% Ar concentration. This occurs because of the remarkable efficiency

of charge exchange reactions between ions of Ar and N₂ molecules in the ground state,



which are subsequently ionized and give rise to N₂ atoms participating in reactions such as dissociative recombination with electrons present in the discharge.

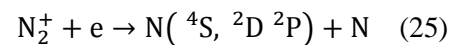

It can be concluded that for plasma type N₂/Ar, a majority of the N₂ atoms are produced by the dissociative recombination

of molecular ions of N_2 . This is achieved by the charge transfer reactions as established in equation (24) and associative ionization of molecules in metastable state. Moreover, the decrease in the fraction of dissociation can be attributed to the decrease in electron energy with increase in filling pressure. By adding Ar to our system, the dissociation fraction is favored because this contributes to increased density of the metastable states of Ar. These states generated in our system interact with the N_2 molecule through Penning excitation, dissociating them into two N_2 atoms. Another contribution to the N_2 atom production is the charge exchange between N_2 molecules and Ar ions followed by a dissociative recombination.

9. Conclusions

The effect of the Argon in the mixing they are studied on the occurrence of the excited and ionized state in the generation of the active species of the Nitrogen. An increased in the occurrence of the $N_2(C^3\Pi_u)$ excited state in comparison with $N_2^+(B^2\Sigma_u^+)$ radiative state is observed with Ar addition.

The induction of Ar within our system causes variations in electron temperature and electron density, which is the consequence of competition between Ar atoms and N_2 molecules by the energy of the electron for excitation and ionization through collision

with these electrons. This competition is manifested in the spectra emitted by the discharge, showing a strong reduction of emissions due to the species of Ar at the same time appearing Nitrogen molecular band increasing the concentration of Argon in the plasma besides It can be concluded that there is a significant contribution of charge transfer reactions and Penning excitement that affect populations of ions, atoms, and molecules in the metastable state.

The fraction of dissociation is evaluated via actinometry, where in the fraction of dissociation can be enhanced by Ar addition. Maximum fraction of dissociation is observed for 10% Ar in the N_2/Ar gas mixture. This occurs by the remarkable efficiency of charge transfer reactions between Ar ions and N_2 molecules in the ground state, giving rise to the excited state of N_2 molecules that can take part in dissociative recombination reactions and lead to the formation of N_2 atoms in the metastable state.

10. Acknowledgments

We are grateful to the Advanced Physics Laboratory (FC-UAEM) for their infrastructure and to CONACyT for their support to perform this research. This research was supported by DGAPA [IN102916], CONACyT [268644], and PROMEP [103.5/13/6623].

References

- [1] A. A. Ovsyannikov and M. F. Zhukov, *Plasma Diagnostic*, Cambridge International Science Publishing, 50-58, 2005.
- [2] P. G. Reyes, C. Torres and H. Martinez, *Radiation Effects & Defects in Solids*, Vol. 169, No. 4, 285-292, 2014.
- [3] T. H. Chung, Y. W. Lee, H. M. Joh and M. A. Song 2011, *AIP Advances*, Vol. 1, 032136
- [4] G. G. Raju, *IEEE Electr. Insul. Mag.*, Vol. 22, 5-23, 2006.
- [5] NIST Atomic Spectra Database Lines Form USA, National Institute of Standards and Technology (NIST) USA, http://physics.nist.gov/PhysRefData/ASD/lines_form.html, (accessed 15.03.16), 2016.
- [6] V. K. Unnikrishnan, K. Alti, V. B. Kartha, C. Santhosh, G. P. Gupta and B. M. Suri, *PRAMANA-Journal Of Physics*, Vol. 74, No. 6, 983-993, 2010.
- [7] H. R. Griem, *Principles of Plasma Spectroscopy*, Cambridge University Press, Cambridge, 1997.
- [8] J. Feng, Z. Wang, Z. Li and W. Ni, *Spectrochimica Acta Part B*, Vol. 65, 549-556, 2010.
- [9] T. Czerwiec, F. Greer and D. B. Graves, *J. Phys. D: Appl. Phys.*, Vol. 38, 4278-4289, 2005.
- [10] H. Akatsuka, Progresses in Experimental Study of N₂ Plasma Diagnostics by Optical emission Spectroscopy, *Chemical Kinetics*, Dr. Vivek Patel (Ed.), ISBN: 978-953-51-0132-1
- [11] Y. W. Lee, H. Ian, T H Chung, *Current Applied Physics*. Vol. 11, S187-S191, 2011.
- [12] N. K. Bibinov, A. A. Fateev, K. Wiesemann, *J Phys D: Appl. Phys.*, Vol. 34, 1819-1826, 2001.
- [13] L. Petitjean and A. Ricard, *J. Phys. D: Appl. Phys.*, Vol. 17, 919-929, 1984.
- [14] A. Qayyum, S. Zeb, S. Ali, A. Waheed and M Zakaullah, *Plasma Chem Plasma Process*, Vol. 25, 551, 2005.
- [15] A. Qayyum, S. Zeb, M. A. Naveed, N. U. Rehman, S. A. Ghauri and M. Zakaullah, *Journal Of Quantitative Spectroscopy & Radiative Transfer*, Vol. 107, 361-371, 2007.
- [16] I. Sugimoto, S. Nakano and H. Kuwano, *J Appl. Phys.*, Vol. 75, 7710, 1994.
- [17] S. Bockel, J. Amorim, G. Baravian, A. Ricard, P. Stratil, *Plasma Sources Sci Technol*, Vol. 5, 567, 1996.

[18] Y. K. Pu, Z. G. Guo, Z. D. Kang, J. Ma, Z. C. Guan, G. Y. Zhang and E. G. Wang, *Pure Appl. Chem.*, Vol. 74, No. 3, 459-464, 2002.

[19] Y W Lee, H I Lee and T H Chung, *Current Applied Physics*, Vol. 11, S187-S191, 2011.